

**ITEM NO. ETBSD0446**

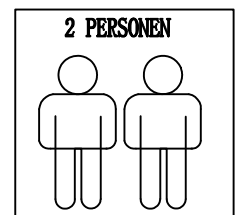

---

NOTE:

---

This brochure contains IMPORTANT safty info. Please read and keep for future reference.

---

# MAINTAINANCE

## AND WARNING

- Keep furniture away from heat.
- Do not clean furniture with harsh cleansers or polish. Do not use detergents, Solvents, abrasives, spray packs or leather cleaner. Use non-color mild soap with warm water clean spills(Mix 1:10 soap to water)
- Do not place furniture under direct sunlight, material will possibly fade over time.
- Do not use on site dry Cleaning machine.
- Children should not climb or jump on the furniture.
- Do not write on furniture without a padded barrier to protect the surface.
- Not for commercial use, For residential use only.



Weight Limitation

30LBS

# PARTS LIST

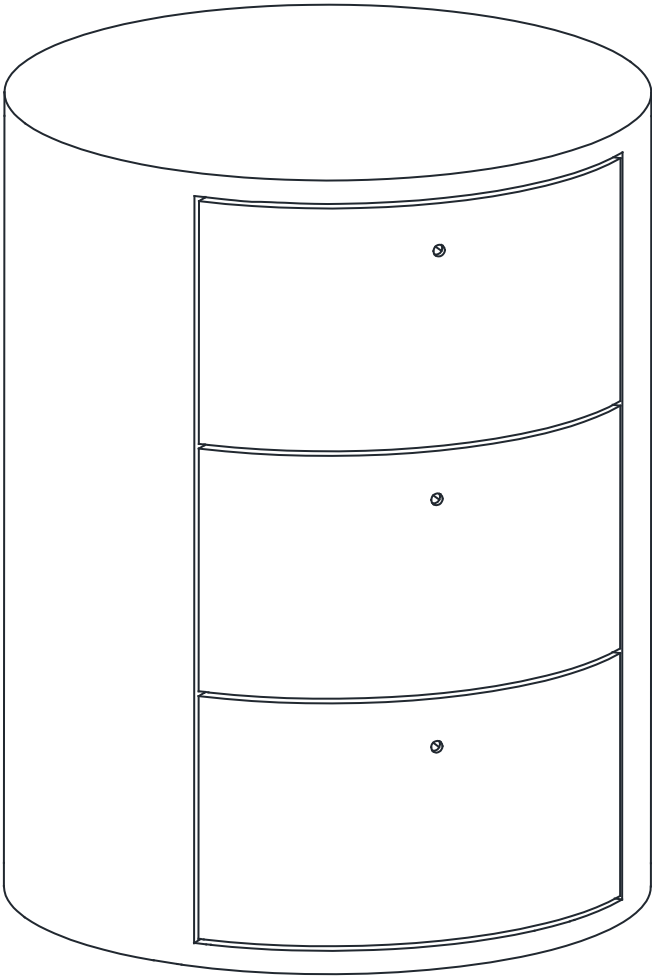

① x1





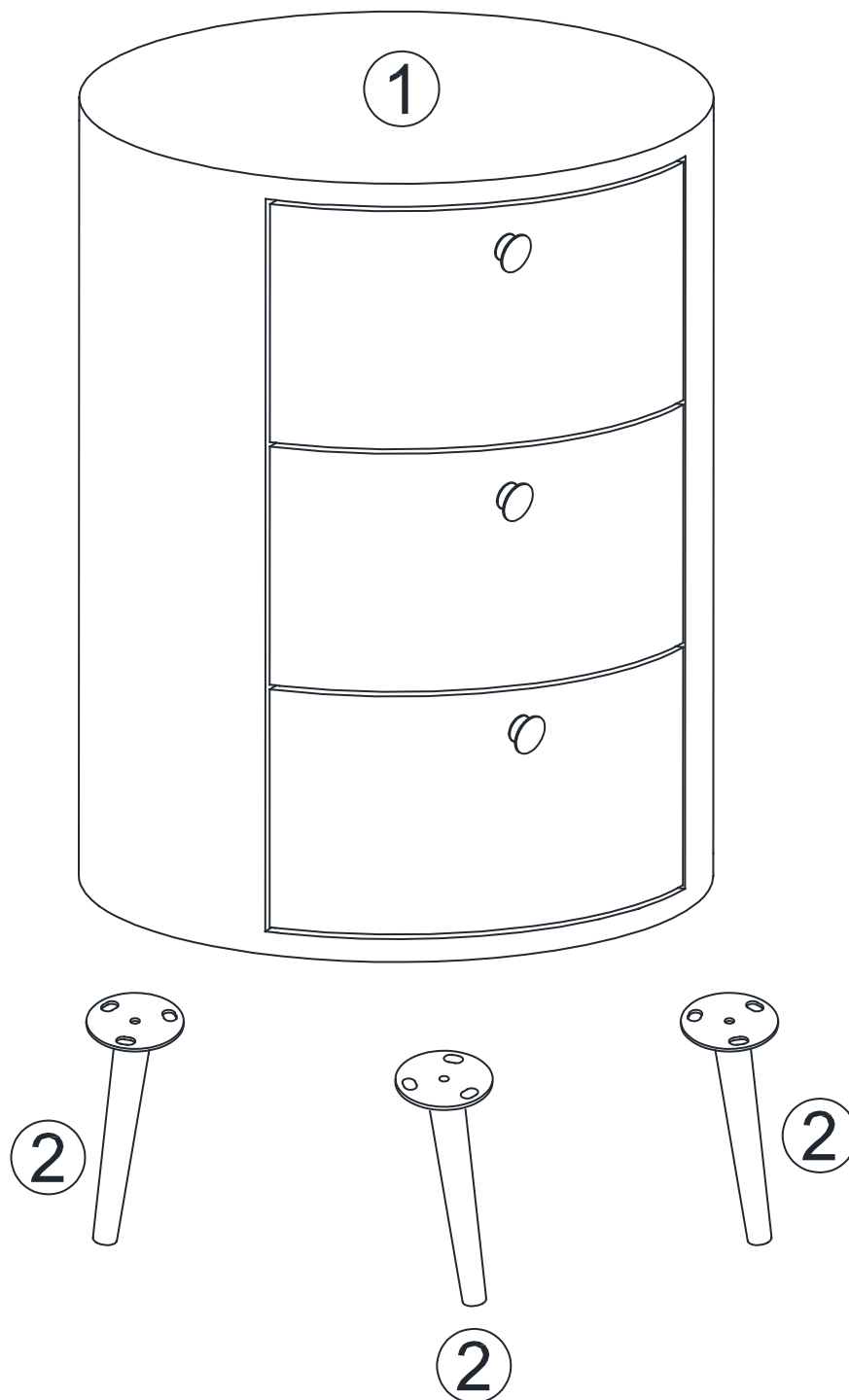







② x3

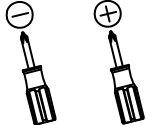





Explosive View

# HARDWARE

A	x3	B	x3	C	x9	D	x1	E	x1
									
		M4*22		M6*10mm		M4			
F	x2	G	x2	H	x1	I	x2	J	x2
									
Ø4*35mm								Ø3.5*14mm	

# SPARE

B	x1	C	x1	F	x1	J	x1
							
M4*22		M6*10mm		Ø4*35mm		Ø3.5*14mm	

Be sure to check all packing material carefully for small parts, which may have come loose inside the carton during shipment.

# ASSEMBLY INSTRUCTION

## STEP 1

Install the legs. Align the hole in the part 2 to the hole in part 1, screw hardware C and tighten by Allenkey D. Turn all the legs outward.

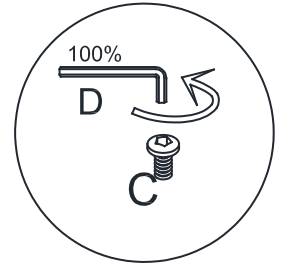
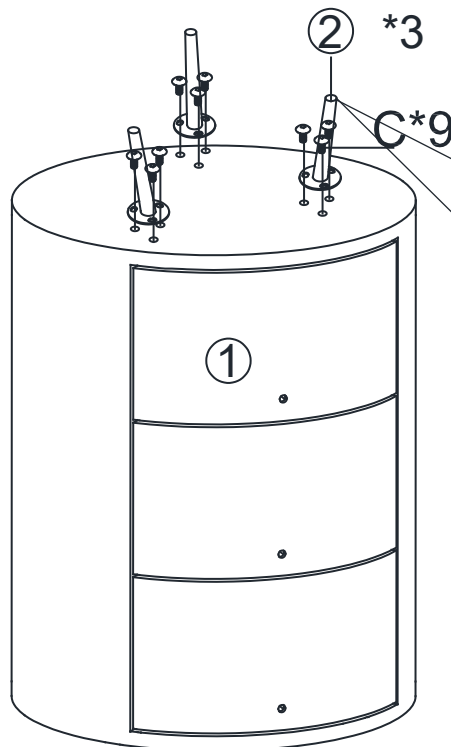



C	x9
	
M6*10mm	

D	x1
	
M4	

## STEP 2

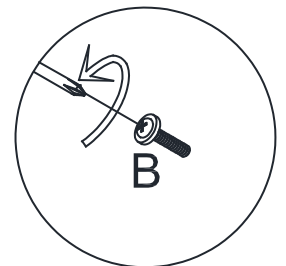
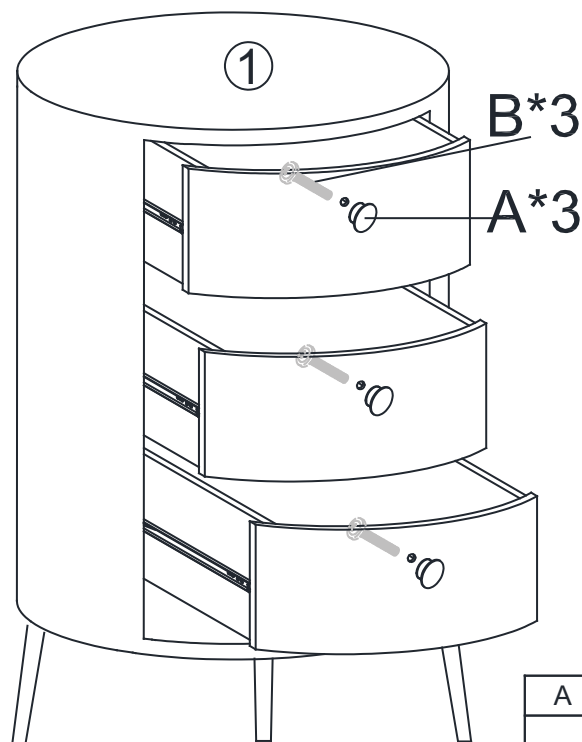
Assemble the drawer puller part A. Align the hole in the part A to the hole in the drawer cover plate in part 1, screw in the screw B and tighten by screwdriver E.



A	x3
	

B	x3
	
M4	



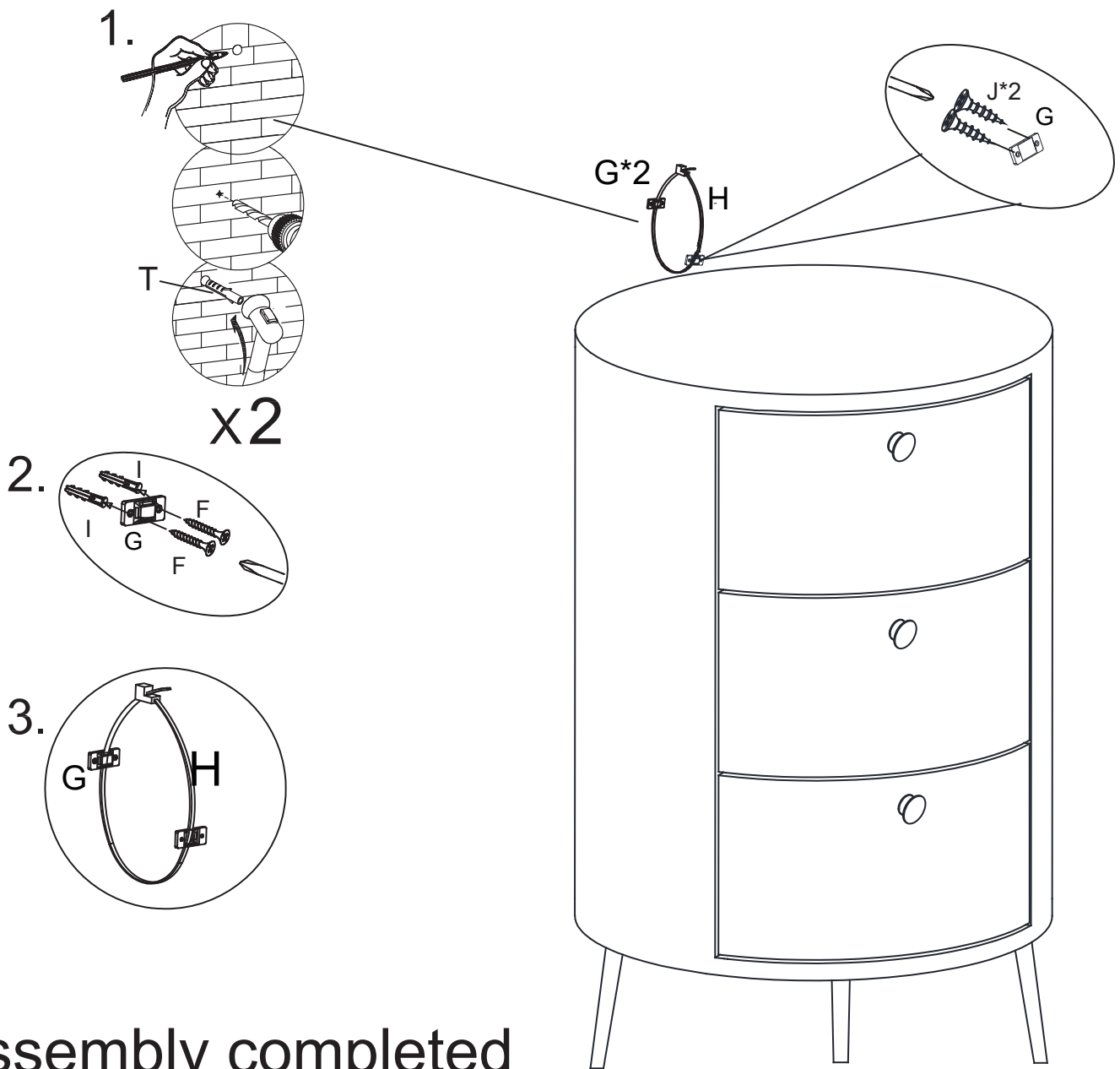

# STEP 3

Install the Anti-collapse device.

1. Install the part G on the back of part 1. the position is near the top of part 1.
2. Mark the position on the wall, this should be same as the position of G where are on the back of panel 1; Drilled and insert the expandable screw I by hammer;
3. Assemble the part G on the wall. Align the hole in the part G to the expandable screw I, screw in and tighten by screwdriver;
4. let the plastic belt H go through the both G and pull to tighten.



Assembly completed

J	x2	F	x2	G	x2	H	x1	I	x2
									
Ø3.5*14mm		Ø4*35mm							

# **WARRANTY**

We strive to offer high-quality products, and we also try our best to satisfy each and every customer that orders from us with product or service as needed. We provide 30 days warranty starting from the time you receive the item. Each customer must provide a record of their order such as the order number, or item receipt for any items that are out of the warranty period you may also still receive replacement parts by purchasing them with our company if they are available.

**Are you having difficulty  
with assembly? Missing parts?**

**Please send email with your order No**

**[customerservice@hulalahome.com](mailto:customerservice@hulalahome.com)**

**For return, Please check the return policy with  
the retailer or MarketPlace you bought from.**

**Appreciated your purchasing from us.  
Pop up your life by our furniture piece!**